



Installation and Operation Manual

BDM-500

Dual Module Macroinverter



USA

Address: 2570 N. First Street, Suite 200, San Jose, CA 95131
TEL: +1 888-598-9901

Japan

Address: 812-0011 福岡市博多区博多駅前 3-10-24 藤井ビル 1F
TEL: +81 092-433-3252
FAX: +81 092-433-3171

China

Address: No.1 Anhe Rd Tsingtao Export Processing Zone, Tsingtao, China 266113
TEL: +86 532 87963900
FAX: +86 532 81100917

Email: info@northernep.com

Web: <http://www.northernep.com>
<http://www.nep-japan.com>
<http://www.micro-inverter.jp>

Rev. 2017-01-12

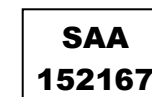

CONTENTS

COMPANY PROFILE	01
1. INTRODUCTION	02
1.1 Greeting	02
1.2 System Compatibility	02
1.3 How to Use This Manual	02
1.4 Label	02
2. SAFETY INSTRUCTION	03
3. FCC COMPLIANCE	03
4. DESIGN	04
5. PARTS NEEDED	04
5.1 NEP Parts	04
5.2 Additional Parts and Tools Requires	05
5.3 Lightning and Surge Suppression	05
5.4 Shipping Information	05
6. INSTALLATION	05
6.1 Pre-installation	05
6.2 Installation Steps	06
Step 1 - System Layout	06
Step 2 - Connect the Wiring Harnesses	07
Step 3 - Install the AC Branch Circuit Junction Box	08
Step 4 - Ground the System	08
Step 5 - Complete the Connection Map	09
Step 6 - Connect the PV Modules	09
Step 7 - Install the BDG 256 Monitoring Gateway	09
7. COMMISSIONING	10
8. OPERATING INSTRUCTIONS	10
9. TROUBLESHOOTING MAINTENANCE	11
10. SPECIFICATIONS	14
11. WARRANTY AND PRODUCT INFORMATION	16

COMPANY PROFILE

Northern Electric & Power Inc. (NEP) is an international supplier of cutting-edge clean energy technologies headquartered in the United States. The company maintains facilities both here and abroad, including a more than 18 acre site in the Tsingtao Export Processing Zone and has more than 650,000 square feet of building space.

The company's founders are well-known experts in the fields of power electronics, automatic control, signal processing, and communications; each holding multiple U.S. and world patents in their specialty areas.

NEP has a complete product line of grid-tied solar inverters, including 180W~600W micro inverters, 1.5kW~5kW single phase solar inverters, 10kW~500kW three-phase solar inverters, and rapid shutdown devices. Field deployment results demonstrated high system efficiency and reliability of NEP solar inverters.

NEP is committed to develop *Clean, Reliable, Affordable and Efficient* (CARE) products for worldwide customers to aid in the transition to a green economy.

1. INTRODUCTION

1.1 Greeting

Thank you for choosing the BDM-500 micro inverter from NEP. This product will maximize your inversion benefit with the minimal amount of design and installation complexity. This document should provide you with all of the necessary steps to correctly install the NEP-500 dual module micro inverter in sites located in North America. However, should you have additional questions please contact NEP's technical representative at support@northernep.com.

1.2 System Compatibility

The BDM-500 is designed to support either one or two 60 or 72 cell modules in grid-tied PV system consists of PV panels, grid-tied inverter and junction boxes. The DC output from the PV panels is converted into AC energy and fed back to the grid through the BDM-500. The BDM-500 also provides effective anti-islanding isolation between the PV module and AC grid output.







1.3 How to Use This Manual

This manual provides detailed product information and installation instructions for the BDM-500 micro solar inverter. Please read through this manual before installation and operation.

 **WARNING:** This indicates a situation where failure to follow instructions may be a safety hazard or cause equipment malfunction. Use extreme caution and follow instructions carefully.

1.4 Label

A label is located on the side of the inverter which includes technical data as well as type and serial number of the device. Safety instructions are listed and explained below:

	Danger! The term "danger" describes an issue which, if ignored can cause personal injury.
	Attention! With the term "attention" a circumstance is listed which may cause property damage if disregarded.
	Instructions for use! Under "Instructions for Use", it is pointed out that installation and operating instructions are to be read and understood before installation or repair.
	Caution, hot surface! Under "Caution, hot surface", it should be noted that surfaces of equipment may be hot and create a burn hazard.
	Special disposal instructions! With "Note Separate Disposal", it is pointed out that this product may not be disposed of with normal garbage. An improperly conducted disposal can lead to damage to the environment.
	ETL Certification This marks certifies that the product complies with all relevant UL requirements for sale in North America.

2. SAFETY INSTRUCTION

 **WARNING:**

PLEASE READ THIS MANUAL PRIOR TO INSTALLATION. PRODUCT DAMAGE RESULTING FROM FAILURE TO FOLLOW THIS MANUAL IS NOT COVERED BY THE WARRANTY.

INSTALLATIONS SHOULD BE DONE ONLY BY CERTIFIED ELECTRICIANS.

NOTHING INSIDE THE INVERTER SHOULD BE MODIFIED

ONLY NEP APPROVED CABLING SHOULD BE USED TO CONNECT MICROINVERTERS

ALL INSTALLATIONS SHOULD FOLLOW THE LOCAL ELECTRICAL CODES. ADDITIONAL PROTECTION FOR THE AC WIRING FROM THE INVERTERS SHOULD BE PROVIDED AND MAY BE REQUIRED BY LOCAL AND NATIONAL WIRING REGULATIONS. THIS PROTECTION IS LIKELY TO INCLUDE RESIDUAL CURRENT DEVICES, EARTH FAULT MONITORS AND CIRCUIT BREAKERS. THIS PRODUCT MAY CAUSE AC CURRENT WITH A DC COMPONENT. IF A RESIDUAL CURRENT-OPERATED PROTECTIVE DEVICE (RCD) OR A MONITORING DEVICE (RCM) IS USED FOR PROTECTION IN CASE OF DIRECT OR INDIRECT CONTACT, ONLY AN RCD OR RCM OF TYPE B IS ALLOWED ON THE AC SIDE OF THIS PRODUCT.

NEVER DISCONNECT THE PV MODULES FROM THE MICRO-INVERTER WITHOUT FIRST ISOLATING THE AC MAINS. ALL PV AND AC CONNECTORS ARE NOT TO BE DISCONNECTED UNDER LOAD. THE AC BRANCH CIRCUIT BREAKERS MUST BE FIRST SWITCHED OFF.

PLEASE CONTACT AUTHORIZED SERVICE AGENTS FOR ANY SERVICE WORK.

BDM-500 IS A GRID-TIED SOLAR INVERTER. IT MAY REQUIRE APPROVAL FROM THE LOCAL UTILITY COMPANY PRIOR TO CONNECTION TO THE POWER GRID.

THE BDM-500 DOES NOT INCLUDE ANY USER SERVICABLE COMPONENTS.

 **WARNING:** THE PV ARRAY SUPPLIES A DC VOLTAGE TO THE MICROINVERTER WHEN EXPOSED TO LIGHT.

3. FCC COMPLIANCE

This equipment has been tested and found to comply with the limits for a Class B digital device, pursuant to part 15 of the FCC Rules. These limits are designed to provide reasonable protection against harmful interference in a residential installation. This equipment generates uses and can radiate radio frequency energy and, if not installed and used in accordance with the instructions, may cause harmful interference to radio communications. However, there is no guarantee that interference will not occur in a particular installation. If this equipment does cause harmful interference to radio or television reception, which can be determined by turning the equipment off and on, the user is encouraged to try to correct the interference by one or more of the following measures:

- Reorient or relocate the receiving antenna.
- Increase the separation between the equipment and the receiver.
- Connect the equipment into an outlet on a circuit different from that to which the receiver is connected.
- Consult the dealer or an experienced radio/TV technician for help.

Changes or modifications not expressly approved by the party responsible for compliance may void the user's authority to operate the equipment.

4. DESIGN

Microinverter technology greatly simplifies the design process compared to conventional string inverter systems. The BD-500 allows for the PV modules to be placed with different azimuths and orientations to maximize site generation. In addition to the layout configuration, a successful design needs to take into account two other considerations: branch circuit sizing and voltage rise calculation.

Layout: Since the BD-500 is a single input device. A layout map showing the location of each PV module and its corresponding microinverter should be first constructed. Care should be taken to review the DC lead length of the PV modules to see if additional jumpers are required to reach the DC input of the BD-500. Each microinverter comes with a number of peelable serial number stickers. Remove a sticker and attach them to the corresponding modules on the site map.

Branch Circuit Sizing: Since the BD-500 uses #12 AWG cabling, NEC code specifies a maximum breaker size of 20A. This limits the branch size to a maximum of seven (7) devices for a 240V system and six (6) devices for a 208V system.

Voltage Rise Calculation: The addition of daisy chained, current producing microinverters on the AC bus results in a sequential rise in voltage along the bus, with the highest at the furthest device. Care must be taken that the resulting voltage doesn't exceed the maximum permissible by code. For a 240 V system, this is 264V and 229V for a 208V system. Please contact NEP technical support should you need more information on this subject.

5. PARTS NEEDED

5.1 NEP Parts

You will need the following parts from NEP:

- Microinverters (one per every 2 modules)
- Protective end cap (one per branch circuit)
- Tail cable (one per branch circuit- 16' long)
- Male connector (optional)
Used to make extension cables
- BDG-256 (or BDG-256P3)



5.2 Additional Parts and Tools Required

In addition to the PV modules, racking, and associated hardware, you'll need the following parts:

- MLPE rail or frame attach clamps (2 per microinverter)
- AC junction boxes (multiple options possible)
- Cordgrip with locknut or strain relief fitting (one per branch circuit)
- A subpanel may be required for systems with multiple branch circuits
- Cable clips
- Sockets, wrenches, torque wrench, multimeter, small flat head screwdriver, and mirror with extension rod
- Lightning and surge suppressor (recommended)

5.3 Lightning and Surge Suppression

Since the NEP Limited Warranty does not cover "acts of God", such as lightning strikes or grid irregularities, NEP strongly recommends inclusion of a surge protection device in all systems. Lightning does not actually need to strike the equipment or building where PV system is installed to cause damage. Often, a strike nearby will induce voltage spikes in the electrical grid that can damage equipment. Additionally, many areas can experience irregularities in electrical grid that can generate similar voltage spikes. While the BDM-500 includes integrated surge protection circuitry, if the surge has sufficient energy the protection circuitry can be exceeded and the equipment can be damaged. Installation of a suitable surge protector significantly increases the protection against such events.

5.4 Shipping Information

The BDM-500 Ships six (6) to a box with each box measuring approximately 18" x 13.5" x 16" and weighing 57 lbs. A typical pallet contains 27 boxes.

6. INSTALLATION

6.1 Pre - installation

Prior to installation, use the multimeter to check the electrical panel to confirm the correct service voltage per the below table. If this voltage is too high it can prevent proper operation of the microinverters. If this is the case, the utility should be notified. However, an NEP technical representative may be able to adjust microinverter operational parameters to accommodate the situation.

Residential	L1 to L2	240 Vac
Commercial	L1 to L2 to L3	208 Vac

Also, please check all microinverters and cabling for any potential damage prior to site deployment. Remember to first create and bring a copy of the layout map. This map should show the physical location of each BDM-500 and their associated PV modules in your installation.

6.2 Installation Steps

WARNING: CONNECT BDM-500S TO THE ELECTRICAL UTILITY GRID ONLY AFTER RECEIVING PRIOR APPROVAL FROM THE UTILITY COMPANY AND LOCAL AHJ.

WARNING: BE AWARE THAT ONLY QUALIFIED PERSONNEL CAN CONNECT BDM-500 TO THE ELECTRICAL UTILITY GRID.

Step 1 – System Layout

Mark the approximate location of each pair of PV modules on the racking system. Place the microinverters at the location called out in the layout map and *loosely* attach to the rails using the MLPE clamps. Check the reach of all DC and AC cabling. DC jumpers may be required for some modules. Reposition as needed.

WARNING: ALLOW A MINIMUM OF 2.75 INCHES BOTH BETWEEN THE TOP OF THE ROOF AND THE BOTTOM OF THE BDM-500 AND BETWEEN THE BACK OF THE PV MODULE AND THE TOP OF THE BDM-500. DO NOT PLACE THE BDM-500 IN A LOCATION SUBJECT TO DIRECT SUNLIGHT.



For ground mount, ballasted, or flat roof deployments it may be necessary to attach the microinverters to the racking frame.

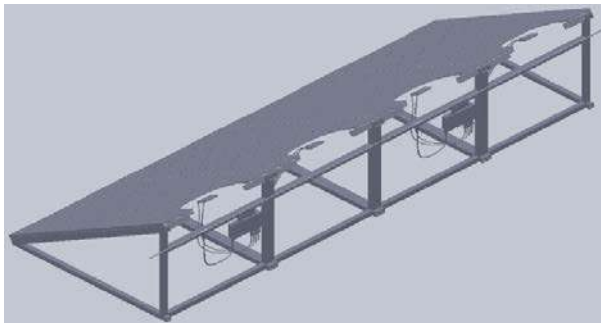

Once the final position is confirmed, secure the microinverters using the MLPE clamps and torque per the manufacturer's specifications. Typical values are about 12 ftlbs (16.3 NM).

Step 2 – Connect the Wiring Harnesses

Each BDM-500 comes with an integrated trunk cable to simplify the AC connection process. The AC trunk cable includes a male connector on one end and a female connector at the other end. Plug the male AC connector of the first BDM-500 into the connector on the tail cable. Plug the female AC connector of the first BDM-500 into the male connector of the next BDM-500 (or jumper cable) and continue this "daisy chain" process to form a continuous AC branch circuit. Terminate the final female connector on the last microinverter in the branch circuit with the protective cap. The connectors are keyed with a snap lock pin. A "click" indicates proper mating. Secure the mated connector pairs and any excess AC cable to the rail or racking using cable clips or wire ties.

WARNING: DO NOT EXCEED THE MAXIMUM NUMBER OF SEVEN (7) BDM-500s IN A 240V AC BRANCH CIRCUIT (SIX (6) FOR 208V) AND EACH BDM-500 AC BRANCH CIRCUIT MUST BE SOURCED FROM A 20A MAXIMUM BREAKER.

Install a protective end cap on the open female AC connector on the last microinverter at the end of the trunk cable.

WARNING: MAKE SURE PROTECTIVE END CAPS HAVE BEEN INSTALLED ON ALL UNUSED AC CONNECTORS. UNUSED AC BDM-500 WIRE HARNESS CONNECTORS ARE LIVE WHEN THE SYSTEM IS ENERGIZED.

The AC branch circuit should look as pictured below:

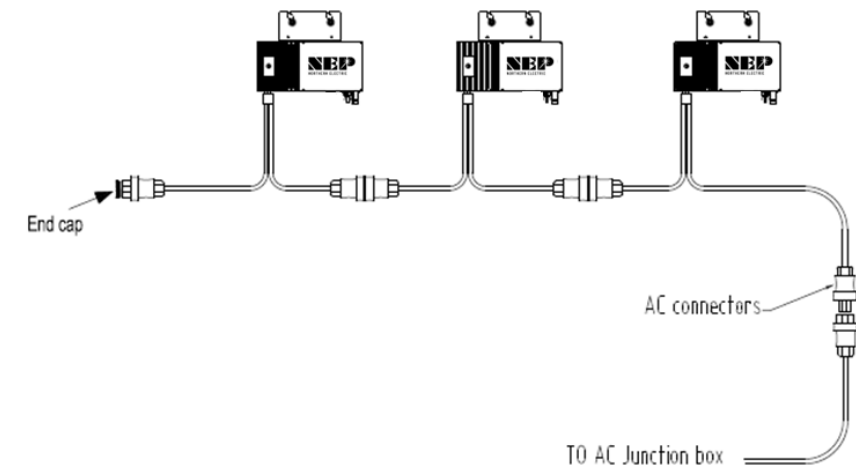

Step 3 – Install the AC Branch Circuit Junction Box

1. Install an appropriate junction box on to the mounting plate.
2. Mount the adapter plate at a suitable location on the racking or frame. This is typically near the end of a row of modules.
3. Feed the open wire end of the tail cable into the junction box and secure with an appropriate cord grip or strain relief fitting. The AC tail cable requires a strain relief connector with an opening of 3/8" in diameter.
4. Feed the connecting wires from either the main service panel or subpanel (if multiple branch circuits are deployed) into the junction box. This is most likely via metal conduit.
5. Connect L1, L2 and Ground from the branch circuit to their corresponding connections from the electrical panel with wire nuts. NEP recommends the applying sealant to the inside cavity of the wire nuts. Seal the junction box.

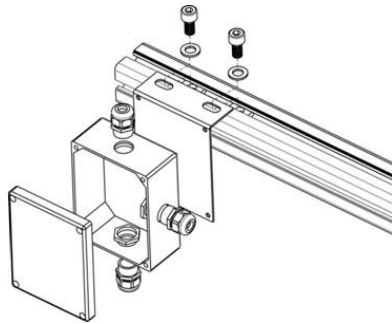

Step 4 – Ground the System

Each BDM-500 has an integrated ground protection circuit. The grounding wire is through the trunk cable, and should be securely connected to the ground connector in the junction box.

Ground the System Through Racking (Option)

BDM-500 may also be grounded through the racking as shown below.

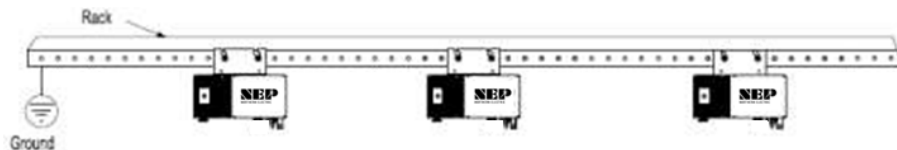

Step 5 – Complete the Connection Map

Each BDM-500 has a removable serial number label located on the mounting plate as well as additional stickers included in the microinverter's protective bag. Remove one and affix it to the corresponding location on the layout map. After entering this data, the BDM-256 will create a virtual array from the map you create.

Step 6 – Connect the PV Modules

Connect all AC all system inter-wiring connections prior to installing the PV modules.

1. Mount the PV modules in the positions corresponding to their associated BDM-500 microinverter. Each BDM-500 comes with two sets of oppositely sexed DC connectors.
2. Connect the positive DC wire from the first PV module to the negatively marked DC connector (male pin) on the BDM-500. Then connect the negative DC wire from the PV module to the positively marked DC connector (female socket) of the BDM-500. Next, do the same for the second set of DC connectors from the second module. Repeat for all remaining PV modules using one BDM-500 for each set of modules. If the system contains an odd number of modules, it is acceptable to connect only one PV module to the BDM-500.

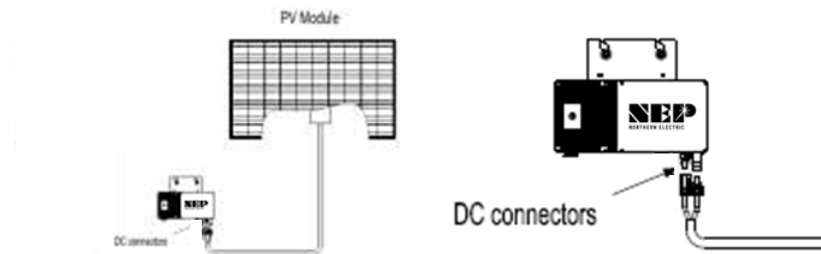

Step 7 – Install the Monitoring Gateway

The BDG-256 (or BDG-256P3) is a versatile gateway that connects each of the BDM-500 microinverter to the NEP server via the cloud, allowing for collection of production and other data useful in system monitoring and trouble shooting. It is easily installed either by plugging into an existing 120V AC interior outlet or by hardwiring into the 240V service in a suitable protective enclosure. Connecting to 240V will maximize the strength of the PLC signal, thereby improving communication. The BDG-256P3 is designed to support commercial three phase systems and should only be located in a protective enclosure. The gateway then will connect to the server via either WiFi or direct Ethernet connection.



Follow the instructions in the NEP *Gateway BDM-256/256P3 Installation and Operations Manual* for specific details on registering the individual microinverters

7. COMMISSIONING



WARNING: ENSURE THAT ALL AC AND DC WIRING IS CORRECT. ENSURE THAT NONE OF THE AC AND DC WIRES ARE PINCHED OR DAMAGED AND THAT ALL JUNCTION BOXES ARE PROPERLY SEALED CLOSE.

Following these steps to commission the BDM-500 PV system:

1. Turn on the circuit breakers for each of the BDM-500 AC branch circuits.
2. Turn on the main service panel utility-grid AC circuit breaker. Your system will start producing power after no more than 5 minutes.
3. The BDM-500 will start to send performance data over the power lines using power line communication (PLC) to the BDG-256. The time required for each BDM-500 in the system to communicate to the BDG-256 will vary with the number of microinverters in the system. For a typical residential system data acquisition should take no more than 20-25 minutes.

8. OPERATING INSTRUCTIONS

The BDM-500 begins operation only after sufficient DC voltage from the PV module is received. At this point the status LED will start flashing.

Status: standby

The LED light toggles on and off at two (2) second intervals

Red: error detected

Orange: no error, but not yet communicating to the BDG-256

Green: no error, and communicating to the BDG-256

Status: producing power

The LED light toggles on and off at one (1) second intervals

Orange: not communicating to the BDG-256

Green: communicating to the BDG-256

Status: grounding fault

The LED light is in *solid red* color.

In case of a fault, the BDM-500 enters a protective mode and stops outputting power. The fault message is usually sent to a connected BDG-256 gateway through the power line communication. The error message is then displayed on the screen of BDG-256 gateway by a 16-bit error code. The table below shows the codes:

Error code	Error
Bit-0	DC over voltage
Bit-1	DC under voltage
Bit-2	hardware error
Bit-3	Inverter over voltage
Bit-4	Frequency over
Bit-5	Frequency under
Bit-6	AC voltage RMS over
Bit-7	AC voltage RMS under
Bit-8	Peak AC voltage over
Bit-9	AC current RMS over
Bit-10	Peak AC current over
Bit-11	Temperature over
Bit-12	ADC error
Bit-13	GFDI fault indicator
Bit-14	Relay fault (BDM-250-AU/BDM-250-EU only)
Bit-15	PLC Communication Error

9. TROUBLESHOOTING AND MAINTENANCE



WARNING: DO NOT ATTEMPT TO REPAIR THE BDM-500; IT CONTAINS NO USER-SERVICEABLE PARTS. IF TROUBLESHOOTING METHODS FAIL, PLEASE CONTACT NEP FOR FURTHER ASSISTANCE.



WARNING: NEVER DISCONNECT THE DC WIRE CONNECTORS UNDER LOAD. ENSURE THAT NO CURRENT IS FLOWING IN THE DC WIRES PRIOR TO DISCONNECTING. AN OPAQUE COVERING MAY BE USED TO COVER THE MODULE PRIOR TO DISCONNECTING.



WARNING: BDM-500 IS POWERED BY DC POWER FROM PV MODULES. MAKE SURE YOU DISCONNECT THE DC CONNECTIONS AND RECONNECT DC POWER TO WATCH FOR THE TWO SECONDS LED ON/OFF TOGGLE AFTER DC IS APPLIED.

 **WARNING:** ALWAYS DISCONNECT AC POWER BEFORE DISCONNECTING PV MODULE WIRES FROM THE BDM-500. THE AC CONNECTOR OF THE FIRST BDM-500 IN A BRANCH CIRCUIT IS SUITABLE AS A DISCONNECTING MEANS ONCE THE AC BRANCH CIRCUIT BREAKER IN THE LOADCENTER HAS BEEN OPENED.

LED indication of error

- **error mode (except for grounding error)**

The LED light flashes in *red* color.

- **NOT communicating with BDG-256, and with no error**

The LED light flashes in *orange* color.

- **grounding fault**

The LED light is in *solid red* color.

Troubleshooting an inoperable BDM -500

To troubleshoot an inoperable BDM-500, follow the steps in the order shown:

1. Check the connection to the utility grid. Verify that the utility voltage and frequency are within allowable ranges shown in the label of BDM-500.
2. Verify utility power is present at the inverter in question by removing AC, then DC power. Never disconnect the DC wires while the BDM-500 is producing power. Re-connect the DC module connectors, and then watch for the LED blinks.
3. Check the AC branch circuit interconnection harness between all the BDM-500. Verify that each inverter is energized by the utility grid as described in the previous step.
4. Make sure that any AC disconnects are functioning properly and are closed.
5. Verify the PV module DC voltage is within the allowable range shown in the label of BDM-500.
6. Check the DC connections between the BDM-500 and the PV module.
7. PLC signal quality may be checked through the interface on the BDG-256 gateway. If the PLC signal is weak, it might be due to the distance between the micro inverters and the gateway. It may also be caused by the interference from other electronic devices. In most cases, signal quality may be significantly improved by moving the BDG-256 to closer to the micro inverter arrays, and/or farther away from other interferers. In some cases, a signal filter (LCF) may be installed to reduce the interference to PLC communication. If there are two or more separate BDM systems close by, it is highly recommended to install LCF for each micro inverter system to block interference from adjacent other systems.
7. If the problem persists, please call customer support at NEP.

 **WARNING:** DO NOT ATTEMPT TO REPAIR THE BDM-500; IT CONTAINS NO USER-SERVICEABLE PARTS. IF TROUBLESHOOTING METHODS FAIL, PLEASE RETURN THE BDM-500 TO YOUR DISTRIBUTOR FOR MAINTENANCE.

Disconnecting a BDM - 500 from the PV Module

To ensure the BDM-500 is not disconnected from the PV modules under load, adhere to the following disconnection steps in the order shown:

1. Disconnect the AC by opening the branch circuit breaker.
2. Disconnect the first AC connector in the branch circuit.
3. Cover the module with an opaque cover.
4. Using a DC current probe, verify there is no current flowing in the DC wires between the PV module and the BDM-500.
5. Care should be taken when measuring DC currents, most clamp-on meters must be zeroed first and tend to drift with time.
6. Disconnect the PV module DC wire connectors from the BDM-500.
7. Remove the BDM-500 from the PV array racking.

Installing a replacement BDM - 500

1. Attach the replacement BDM-500 to the PV module racking using hardware recommended by your module racking vendor in the same location as the one previously removed.
2. Connect the AC cable of the replacement BDM-500 and the neighboring BDM-500s to complete the branch circuit connections.
3. Obtain serial number of the replacement BDM-500
Each BDM-500 has a removable serial number located on the mounting plate and additional stickers in the shipping bag.
4. Reconnect the PV Modules.
First connect the positive DC wire from the PV module to the negatively marked DC connector (male pin) of the BDM-500. Then connect the negative DC wire from the PV module to the positively marked DC connector (female socket) of the BDM-500. Repeat for the remaining PV modules.
5. Replace the old PLC ID in the BDG-256 gateway with the new PLC ID of the newly installed micro inverter.

10. SPECIFICATIONS

*per IEEE1547A

MODEL		BDM-500-240A	BDM-500-208A	BDM-500
INPUT(DC)	Max Recommended PV Power(Wp)	750	750	750
	Max DC Open Circuit Voltage(Vdc)	60	60	60
	Max DC Input Current (Adc)	25	25	25
	MPPT Tracking Accuracy	>99.5%	>99.5%	>99.5%
	MPPT Tracking Range(Vdc)	22-55	22-55	22-55
OUTPUT(AC)	Peak AC Output Power(Wac)	550	550	550
	Rated AC Output Power(Wac)	500	500	500
	Nominal Power Grid Voltage(Vac)	208	240	230
	Allowable Power Grid Voltage(Vac)	183-228 (Adjustable*)	211-264 (Adjustable*)	180-264 (Adjustable)
	Allowable Power Grid Frequency(Hz)	59.3-60.5(Adjustable*)	59.3-60.5(Adjustable*)	45.5-54.5 (Adjustable)
	THD	<3% (at rated power)	<3% (at rated power)	<3% (at rated power)
	Power Factor	>0.99 (at rated power)	>0.99 (at rated power)	>0.99 (at rated power)
SYSTEM EFFICIENCY	CEC Efficiency	95.5%	95.5%	95.5%
	Night Time Tire Loss(W)	0.11	0.11	0.11
PROTECTION FUNCTIONS	Over/Under Voltage Protection	Yes	Yes	Yes
	Over/Under Frequency Protection	Yes	Yes	Yes
	Anti-Islanding Protection	Yes	Yes	Yes
	Over Current Protection	Yes	Yes	Yes
	Reverse DC Polarity Protection	Yes	Yes	Yes
	Overload Protection	Yes	Yes	Yes
	Ground Fault Detection	Integrated	Integrated	Integrated
	Protection Degree	NEMA-6	NEMA-6	NEMA-6
	Environment Temperature	-40°C ~+65°C	-40°C ~+65°C	-40°C ~+65°C
	Operating Temperature	-40°C ~ +85°C	-40°C ~ +85°C	-40°C ~ +85°C
OTHER PARAMETERS	Display	LED LIGHT	LED LIGHT	LED LIGHT
	Communications	POWERLINE	POWERLINE	POWERLINE
	Dimension (D-W-H mm)	277*132*50	277*132*50	277*132*50
	Weight(Kg)	2.9	2.9	2.9

11 .WARRANTY AND PRODUCT INFORMATION

What does this warranty cover and how long does it last?

This Limited Warranty is provided by Northern Electric & Power Co. Ltd (NEP) and covers defects in workmanship and materials in your BDM-500 Grid-Tied Inverter. This Warranty Period lasts for 10 years from the date of purchase at the point of sale to you, the original end user customer, unless otherwise agreed in writing. You will be required to demonstrate proof of purchase to make warranty claims.

This Limited Warranty is transferable to subsequent owners but only for the unexpired portion of the Warranty Period. Subsequent owners also require original proof of purchase as described in "What proof of purchase is required?"

What will NEP do?

During the Warranty Period, NEP will, at its option, repair the product (if economically feasible) or replace the defective product free of charge, provided that you notify NEP of the product defect within the Warranty Period, and provided that NEP through inspection establishes the existence of such a defect and that it is covered by this Limited Warranty.

NEP will, at its option, use new and/or reconditioned parts in performing warranty repair and building replacement products. NEP reserves the right to use parts or products of original or improved design in the repair or replacement. NEP repairs or replaces a product, its warranty continues for the remaining portion of the original Warranty Period or 90 days from the date of the return shipment to the customer, whichever is greater. All replaced products and all parts removed from repaired products become the property of NEP.

How do you get service?

If your product requires troubleshooting or warranty service, contact your merchant. If you are unable to contact your merchant, or the merchant is unable to provide service, contact NEP directly at:

Northern Electric & Power Inc

Email: support@northernep.com

What does this warranty not cover?

Claims are limited to repair and replacement or if in NEP's discretion that is not possible, reimbursement up to the purchase price paid for the product. NEP will be liable to you only for direct damages suffered by you and only up to a maximum amount equal to the purchase price of the product.

This Limited Warranty does not warrant uninterrupted or error-free operation of the product or cover normal wear and tear of the product or costs related to the removal, installation, or troubleshooting of the customer's electrical systems. This warranty

does not apply to and NEP will not be responsible for any defect or damage to: a) the product if it has been misused, neglected, improperly installed, physically damaged or altered, either internally or externally, or damaged from improper use or use in an unsuitable environment; b) the product if it has been subjected to fire, water, generalized corrosion, biological infestations, or input voltage that creates operating conditions beyond the maximum or minimum limits listed in the NEP product specifications including high input voltage from generators and lightning strikes; c) the product if repairs have been done to it other than by NEP or its authorized service centers (hereafter "ASCs"); d) the product if it is used as a component part of a product expressly warranted by another manufacturer; e) the product if its original identification (trade-mark, serial number) markings have been defaced, altered, or removed; f) the product if it is located outside of the country where it was purchased; and g) any consequential losses that are attributable to the product losing power whether by product malfunction, installation error or misuse.

Disclaimer Product

THIS LIMITED WARRANTY IS THE SOLE AND EXCLUSIVE WARRANTY PROVIDED BY NEP IN CONNECTION WITH YOUR NEP PRODUCT AND IS, WHERE PERMITTED BY LAW, IN LIEU OF ALL OTHER WARRANTIES, CONDITIONS, GUARANTEES, REPRESENTATIONS, OBLIGATIONS AND LIABILITIES, EXPRESS OR IMPLIED, STATUTORY OR OTHERWISE IN CONNECTION WITH THE PRODUCT, HOWEVER ARISING (WHETHER BY CONTRACT, TORT, NEGLIGENCE, PRINCIPLES OF MANUFACTURER'S LIABILITY, OPERATION OF LAW, CONDUCT, STATEMENT OR OTHERWISE), INCLUDING WITHOUT RESTRICTION ANY IMPLIED WARRANTY OR CONDITION OF QUALITY, MERCHANTABILITY OR FITNESS FOR A PARTICULAR PURPOSE. ANY IMPLIED WARRANTY OF MERCHANTABILITY OR FITNESS FOR A PARTICULAR PURPOSE TO THE EXTENT REQUIRED UNDER APPLICABLE LAW TO APPLY TO THE PRODUCT SHALL BE LIMITED IN DURATION TO THE PERIOD STIPULATED UNDER THIS LIMITED WARRANTY.

IN NO EVENT WILL NEP BE LIABLE FOR: (a) ANY SPECIAL, INDIRECT, INCIDENTAL OR CONSEQUENTIAL DAMAGES, INCLUDING LOST PROFITS, LOST REVENUES, FAILURE TO REALIZE EXPECTED SAVINGS, OR OTHER COMMERCIAL OR ECONOMIC LOSSES OF ANY KIND, EVEN IF NEP HAS BEEN ADVISED, OR HAD REASON TO KNOW, OF THE POSSIBILITY OF SUCH DAMAGE, (b) ANY LIABILITY ARISING IN TORT, WHETHER OR NOT ARISING OUT OF NEP'S NEGLIGENCE, AND ALL LOSSES OR DAMAGES TO ANY PROPERTY OR FOR ANY PERSONAL INJURY OR ECONOMIC LOSS OR DAMAGE CAUSED BY THE CONNECTION OF A PRODUCT TO ANY OTHER DEVICE OR SYSTEM, AND (c) ANY DAMAGE OR INJURY ARISING FROM OR AS A RESULT OF MISUSE OR ABUSE, OR THE INCORRECT INSTALLATION, INTEGRATION OR OPERATION OF THE PRODUCT.

IF YOU ARE A CONSUMER (RATHER THAN A PURCHASER OF THE PRODUCT IN THE COURSE OF A BUSINESS) AND PURCHASED THE PRODUCT IN A MEMBER STATE OF THE EUROPEAN UNION, THIS LIMITED WARRANTY SHALL BE SUBJECT TO YOUR STATUTORY RIGHTS AS A CONSUMER UNDER THE EUROPEAN UNION PRODUCT WARRANTY DIRECTIVE 1999/44/EC AND AS SUCH DIRECTIVE HAS BEEN IMPLEMENTED IN THE EUROPEAN UNION MEMBER STATE WHERE YOU PURCHASED THE PRODUCT. FURTHER, WHILE THIS LIMITED WARRANTY GIVES YOU SPECIFIC LEGAL RIGHTS, YOU MAY HAVE OTHER RIGHTS WHICH MAY VARY FROM EU MEMBER STATE TO EU MEMBER STATE OR, IF YOU DID NOT PURCHASE THE PRODUCT IN AN EU MEMBER STATE, IN THE COUNTRY YOU PURCHASED THE PRODUCT WHICH MAY VARY FROM COUNTRY TO COUNTRY AND JURISDICTION TO JURISDICTION.

Warranty Card

Customer Information

Name: _____

Address: _____

City: _____ State: _____ Zip Code: _____

Tel: _____ Fax: _____ E-mail: _____

System Information

Fault Product(s) Serial Numbers: _____

System Commissioning Date: _____ Product Models: _____

No. of Products Used: _____ Bill of Lading Date: _____

Fault Product(s) Quantities: _____ Fault Time/Date: _____

Fault Message(s) or Code(s): _____

Brief Fault Description and Photos (monitoring gateway is required for verification):

Installation Information

Modules Used: _____

Modules Quantity: _____ Inverters quantity per string: _____

Installation Company Name: _____

Installer Name: _____

For the information on our warranty terms and conditions,
please see our website: www.northernep.com/en
All fields must be completed in order to process claim.

Customer Signature: **Date:**

*All rights reserved by NEP. This information is subject to changes without notice.



USA

Address: 2570 N. First Street, Suite 200, San Jose, CA 95131
TEL: +1 888-598-9901

Japan

Address: 812-0011 福岡市博多区博多駅前 3-10-24 藤井ビル 1F
TEL: +81 092-433-3252
FAX: +81 092-433-3171

China

Address: No.1 Anhe Rd Tsingtao Export Processing Zone, Tsingtao, China 266113
TEL: +86 532 87963900
FAX: +86 532 81100917

Email: info@northernep.com

Web: <http://www.northernep.com>

<http://www.nep-japan.com>

<http://www.micro-inverter.jp>